

(MS)

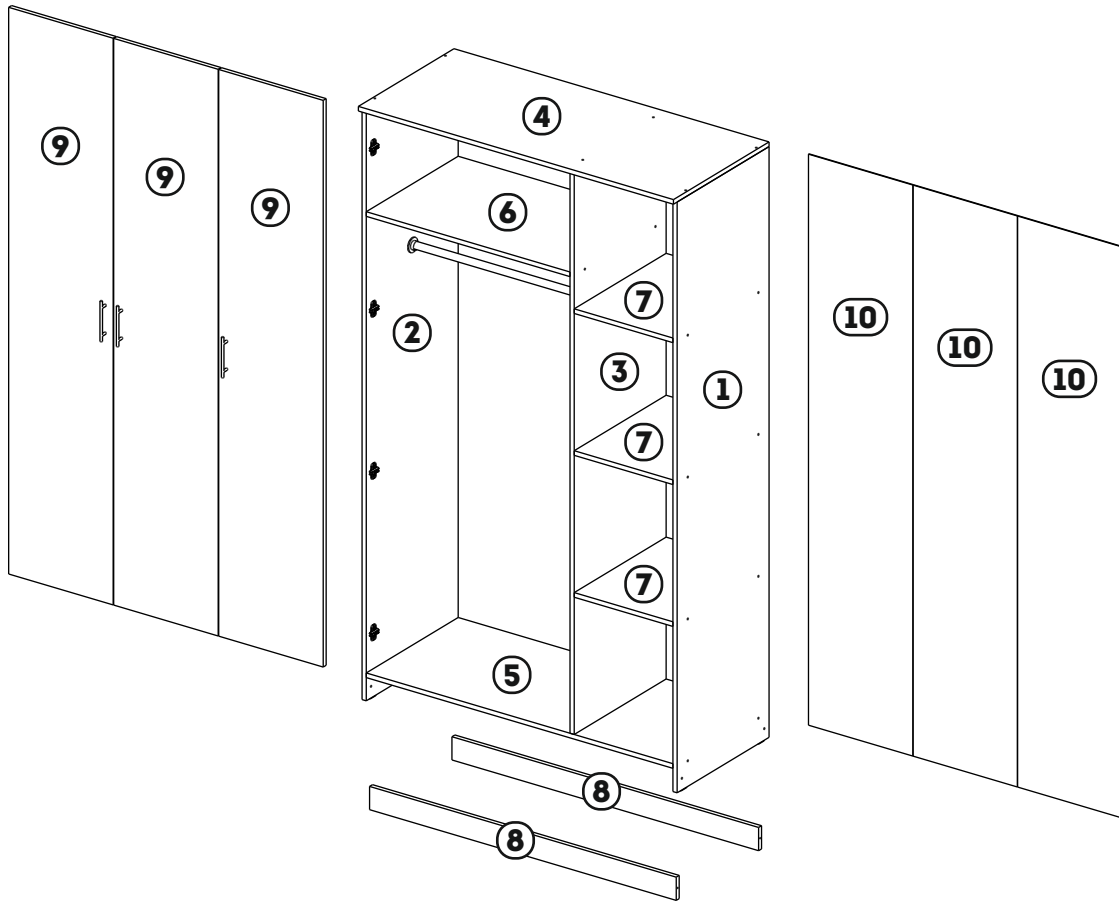

No	a*b	X
1	2034x500	1
2	2034x500	1
3	1938x500	1
4	1200x520	1
5	1168x500	1
6	776x500	1
7	376x500	3
8	80x1168	2
9	1951x398	3
10	1966x398	3

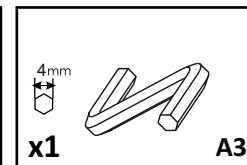

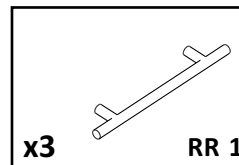
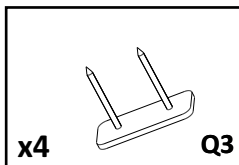
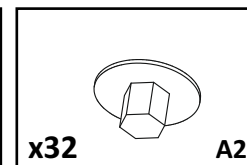
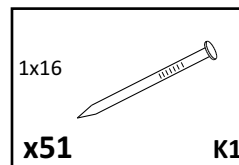
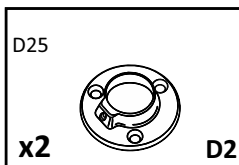
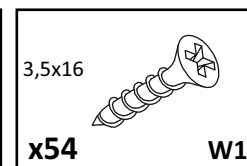
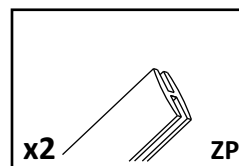
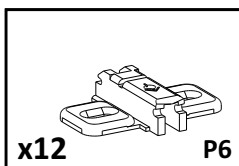
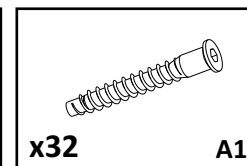
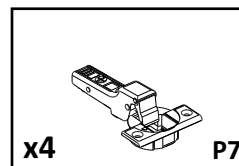
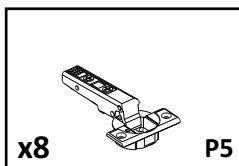
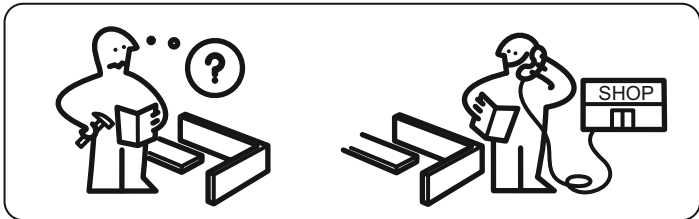
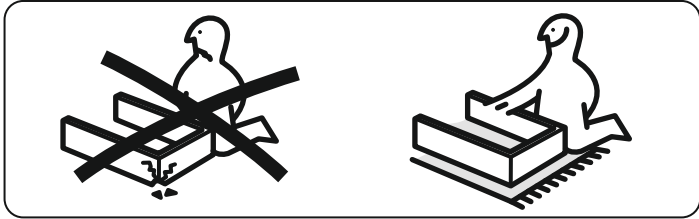
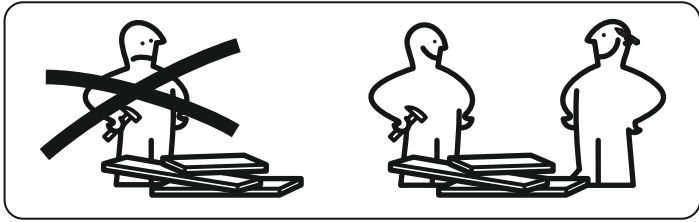

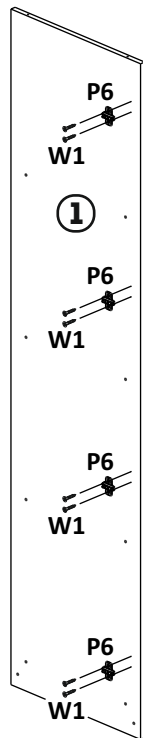
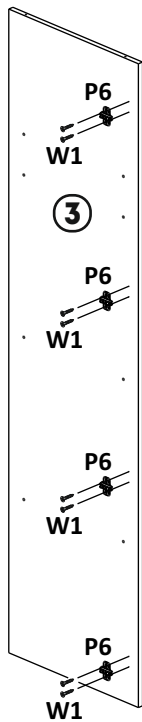
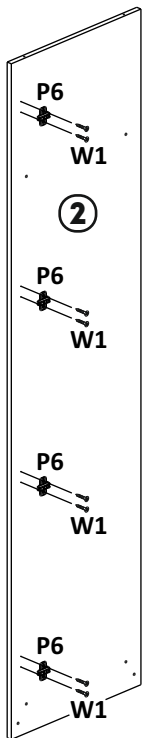
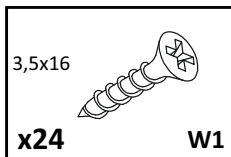
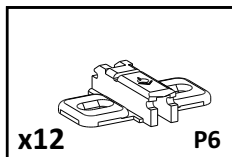
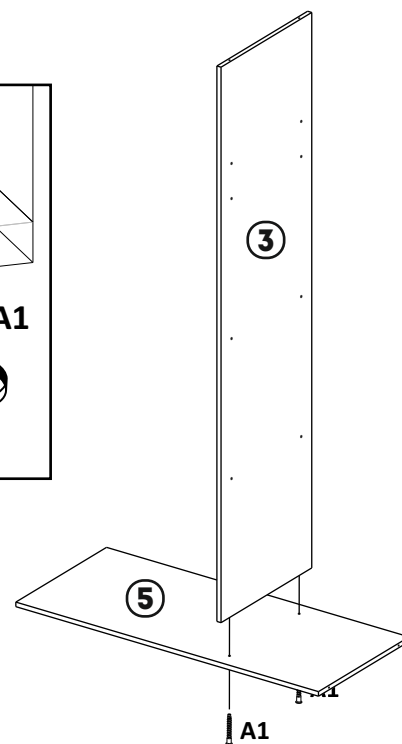
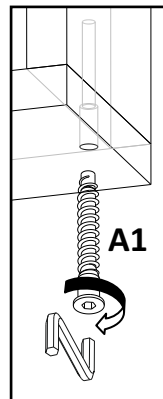
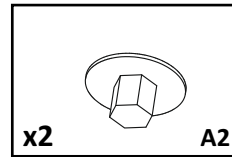
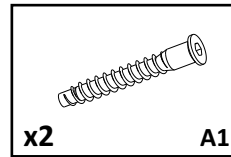
1**2**

3

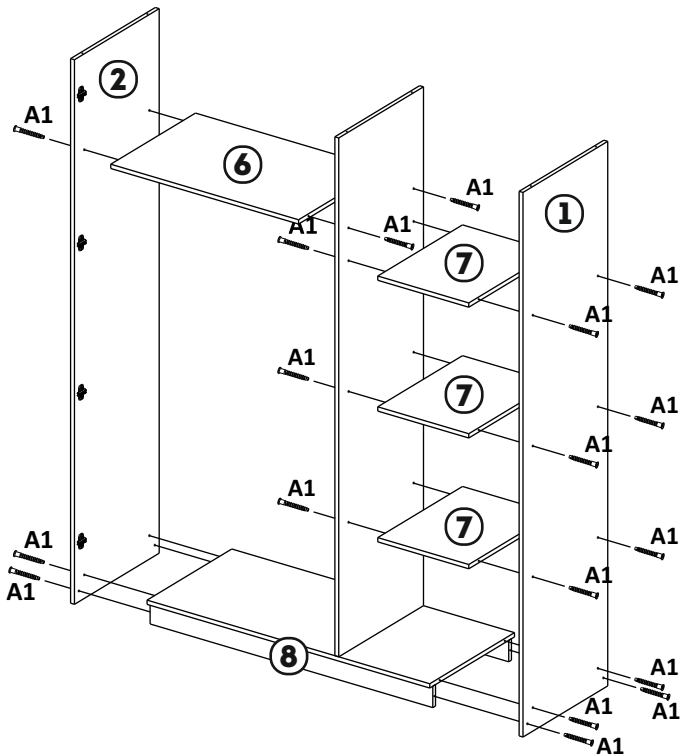
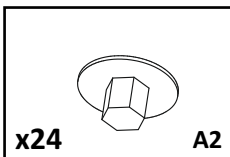
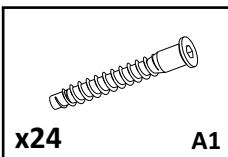

4

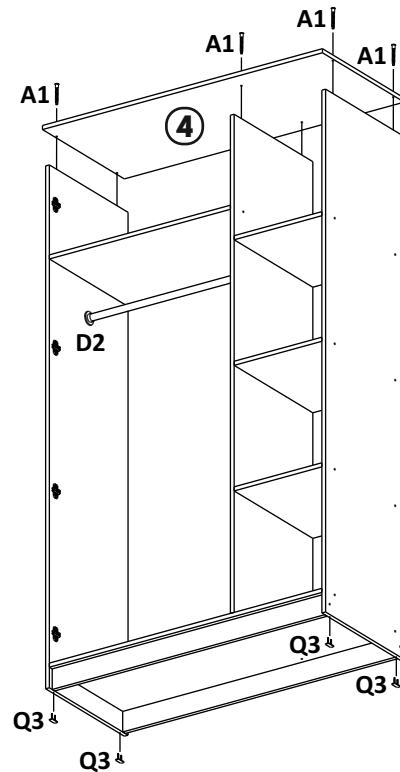
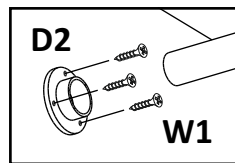
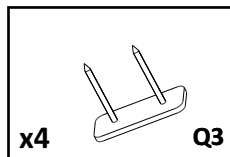
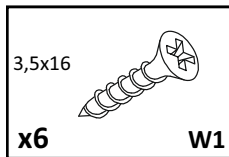
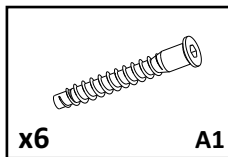

5

x2

ZP

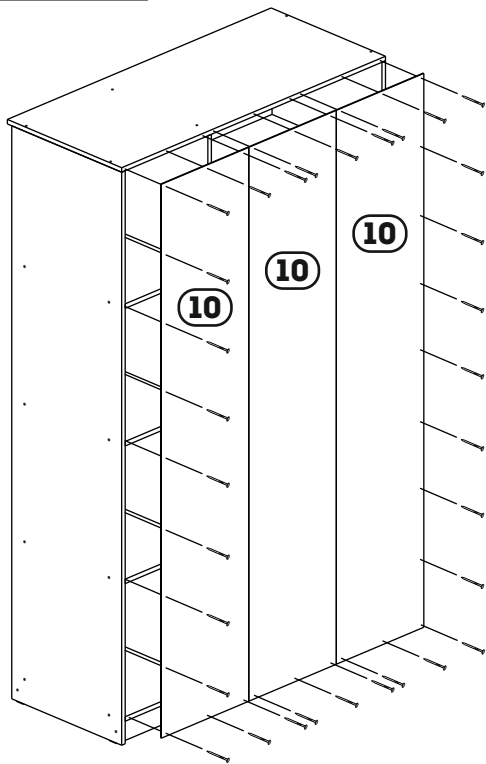
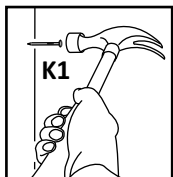
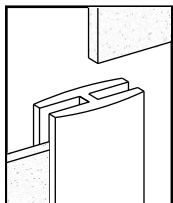
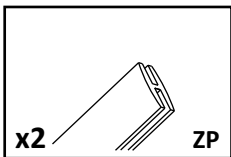

6

x8

P5

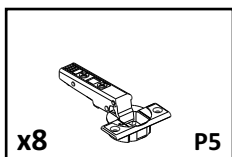

x4

P7

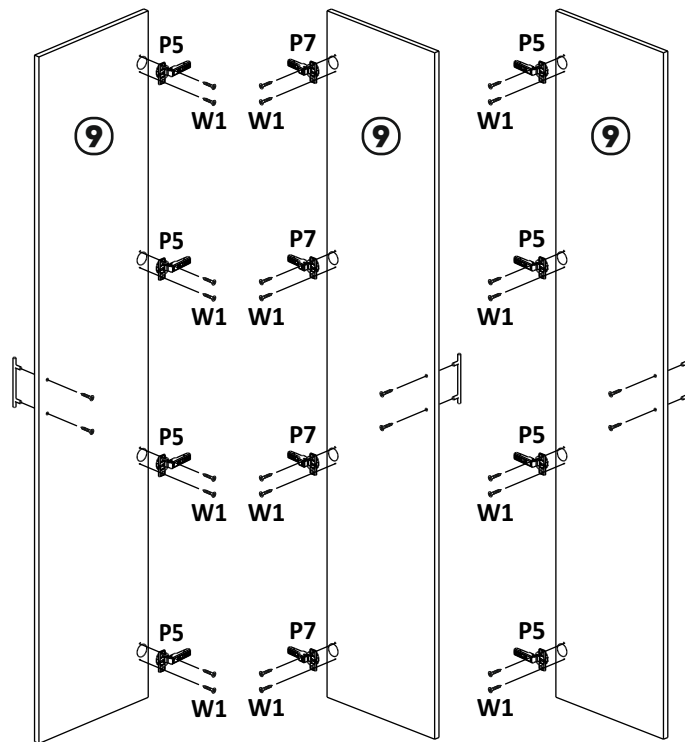
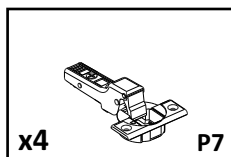

7

7

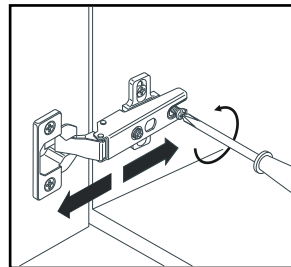
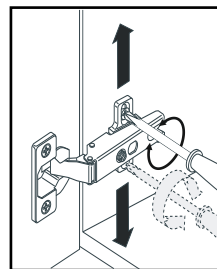
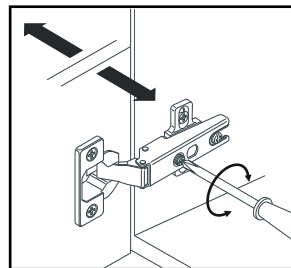
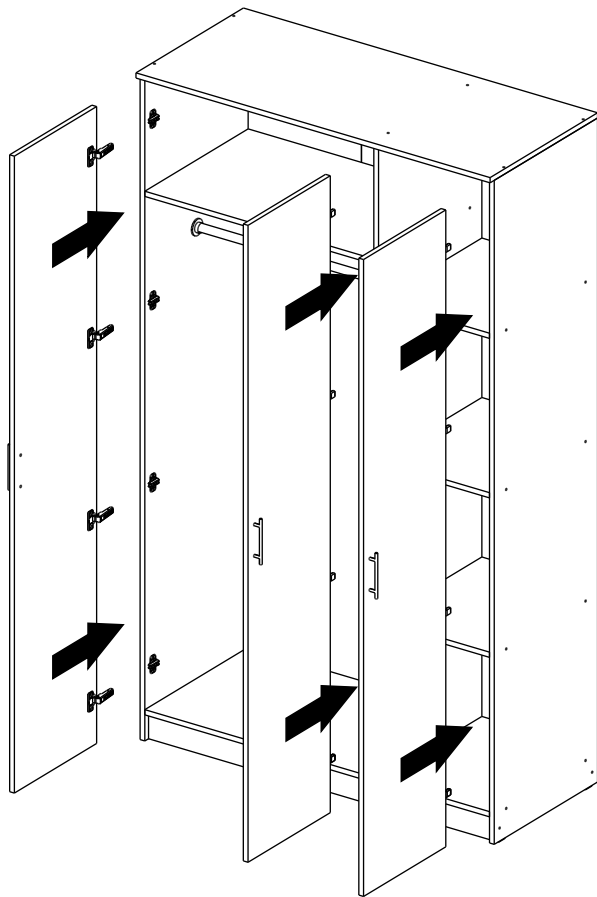

8